



Programa de lectoescritura



la letra M



Normas de uso

La realización de estas fichas por parte del niño, no nos va a asegurar que se hayan conseguido los todos objetivos que se proponen y con el suficiente calado para poder extrapolarlos a otro tipo de actuaciones.

Por lo que se hacen necesarias una serie de condiciones mínimas de ambientación por parte de la persona que administra la ficha. Entre ellas tenemos:

- ❖ **Correcta explicación de los fines** que se quieren conseguir con cada una de las actividades que vamos a realizar, para que el niño sea consciente de que es lo que tiene que hacer y lo realice con los mejores procedimientos.
- ❖ **Clima de estimulación adecuado** para realizar las fichas, en todo momento debemos de lograr hacer la tarea interesante en sí misma. La estimulación se debe de basar en refuerzos positivos jamás en un programa de premios y castigos.
- ❖ **Evaluación de resultados**, en todo programa es fundamental el evaluar los resultados, haciendo ver los errores cometidos, en ningún modo insistir en ellos, sino ser la fuente de estimulación para mejorar los resultados futuros.

- ❖ **Continuo diálogo** entre el niño y el tutor, es muy importante que se establezca un dialogo previo entre ambos para así conseguir, que antes durante y después de la realización del programa, se vayan impartiendo constantes reorientaciones educativas, estímulos, apreciaciones, pistas, etc.
- ❖ **Método y constancia** en la realización del programa. La realización de cualquier programa, requiere ser constantes a la hora de llevarlo a cabo y llevar siempre el mismo método de trabajo.
- ❖ **Asimilación de los objetivos por parte del administrador del programa** que tiene que tener claro en cada momento cuales son los objetivos que se pretenden con la realización de cada una de las actividades que se proponen.
- ❖ **Es el punto de partida** desde el cual el profesor puede dar rienda suelta a su imaginación para él preparar sus propias actividades de acuerdo con los criterios propios de sus contexto de trabajo: tipo de alumnado, situación académica, etc.
- ❖ **La progresión** es diferente para cada niño, dependiendo de las características individuales muy sutiles y de las características de la propia diferencia.

Estas pautas de trabajo son de fácil asimilación para aquella persona que va a ser la encargada de realizar el programa, ya sea el profesor, el terapeuta, padre o tutor, etc.

<http://orientacionandujar.wordpress.com/>

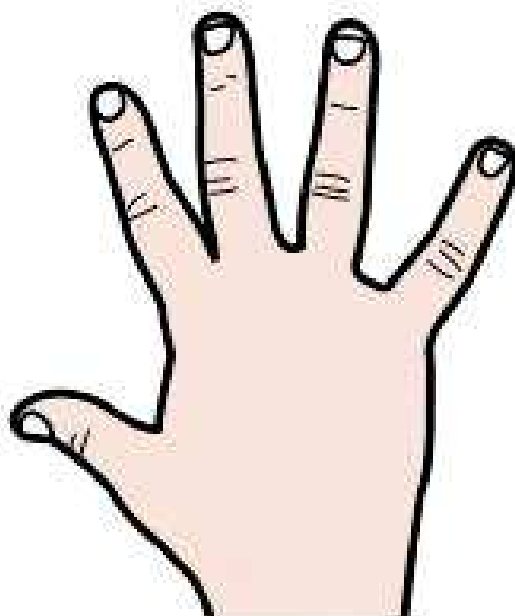
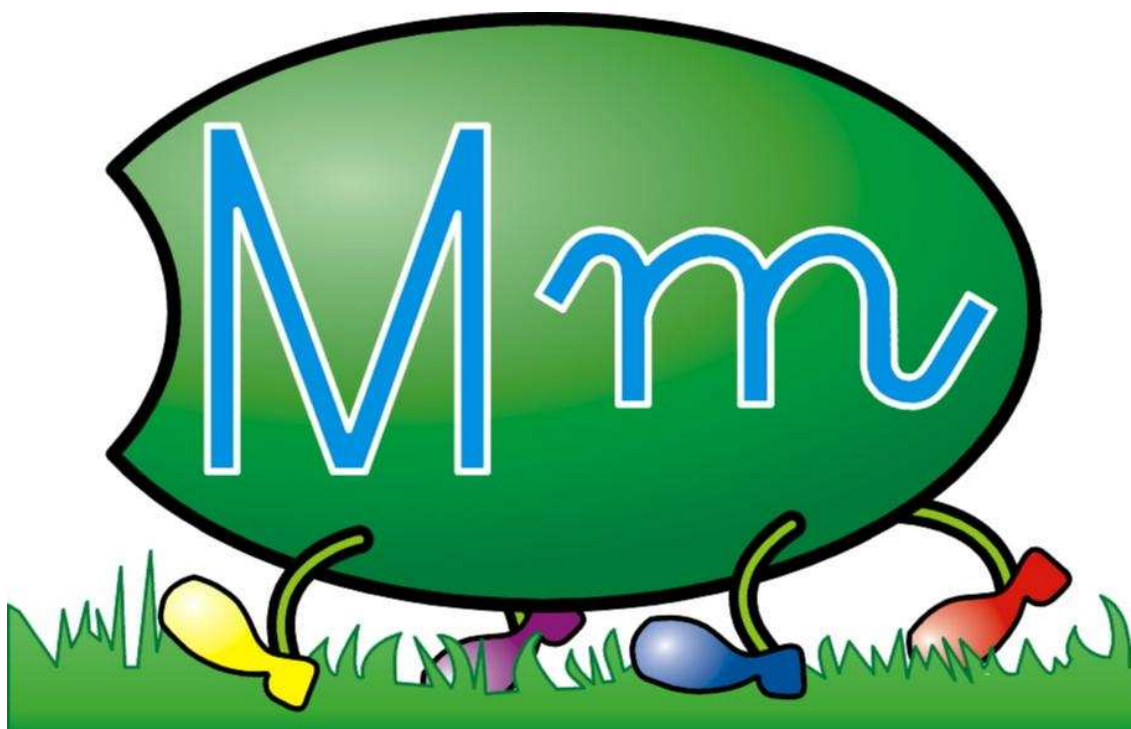



Nombre..... Fecha.....

LA LETRA m



m m m m m

Empty handwriting practice grid for the letter 'm'.



m m m m m

Empty handwriting practice grid for the letter 'm'.



m m m m m

Empty handwriting practice grid for the letter 'm'.



m m m m m

Empty handwriting practice grid for the letter 'm'.



Nombre..... Fecha.....

LA LETRA M



MMMM

Empty handwriting practice grid.

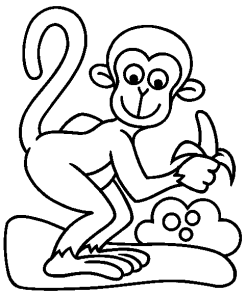

MMMM

Empty handwriting practice grid.



MMMM

Empty handwriting practice grid.



MMMM

Empty handwriting practice grid.



Nombre..... Fecha.....

LA LETRA m

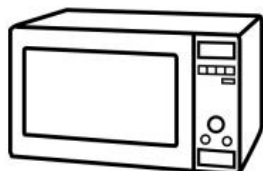

m m m m m

.....



m m m m m

.....



m m m m m

.....



m m m m m

.....



Nombre..... Fecha.....

LA LETRA M



MMM

.....



MMM

.....



MMM

.....



MMM

.....



Nombre..... Fecha.....

LA LETRA m

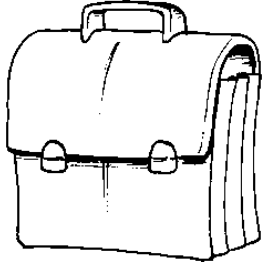

mmm

m



mmm

mmm



m



mmm

m



Nombre..... Fecha.....

LA LETRA m



m m m m m

m

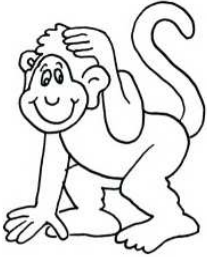

m m m m m

m



m m m m m

m

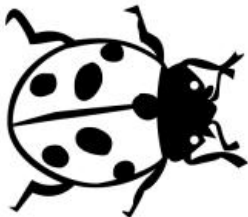

m m m m m

m



Nombre..... Fecha.....

LA LETRA M



m m

m

m m



.....

m m

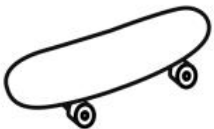

m

m m



m



Nombre..... Fecha.....

LA LETRA M



m m m

m



m m m

m

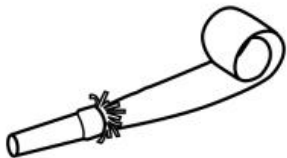

m m m

m

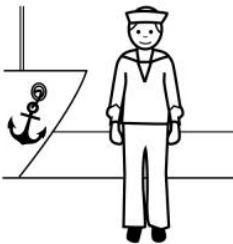

m m m

m



Nombre..... Fecha.....

LA LETRA m



mmm



mmm



mmm



mmm



Nombre..... Fecha.....

LA LETRA M



MMM

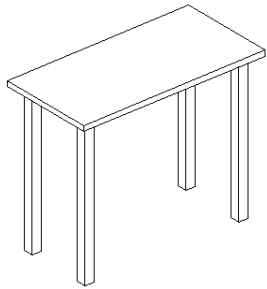

MMM



MMM



MMM



Nombre..... Fecha.....

LA LETRA m

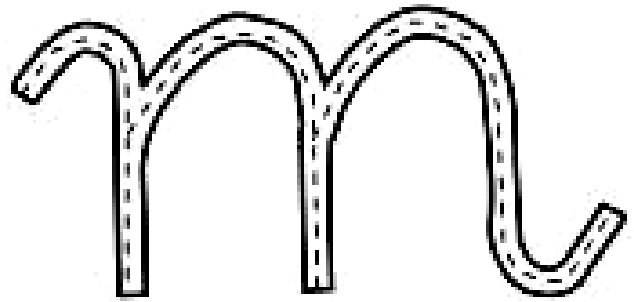
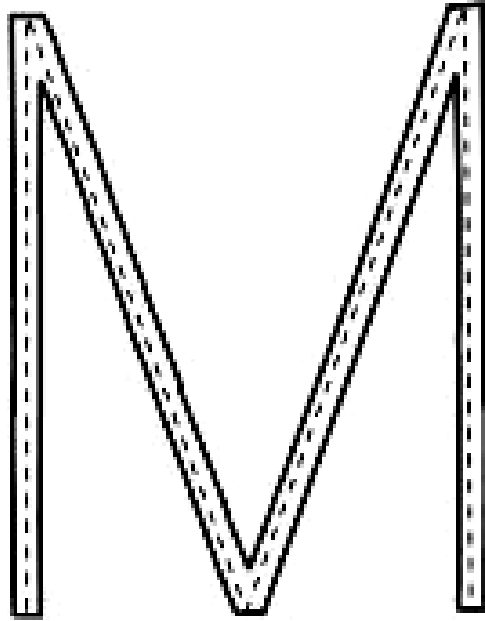

m m m m M M M M

Blank handwriting lines for practice.

ma me mi mo mu

Blank handwriting lines for practice.



Nombre..... Fecha.....

LA LETRA m

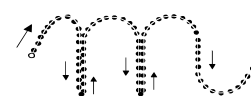
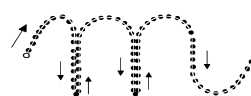
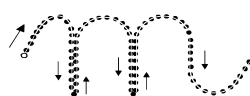
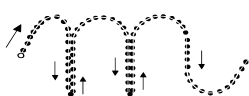
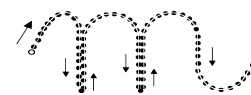
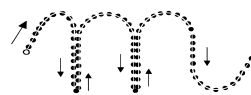
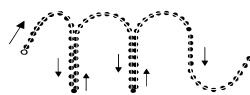
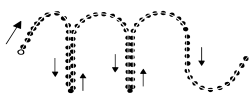
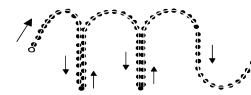
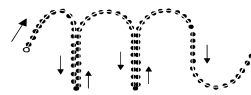
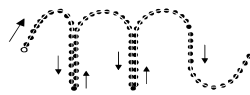
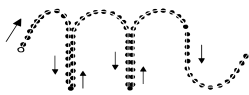
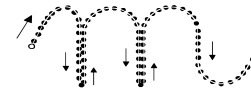
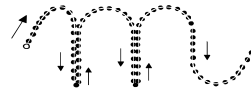
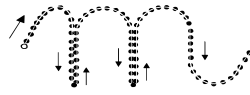
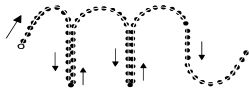
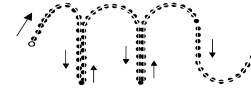
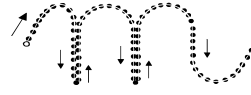
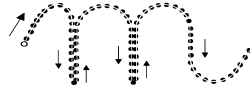
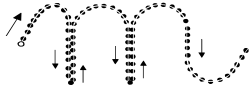



Nombre..... Fecha.....

LA LETRA m

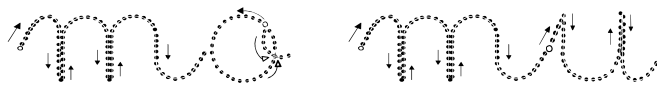
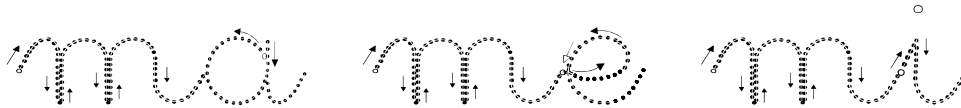
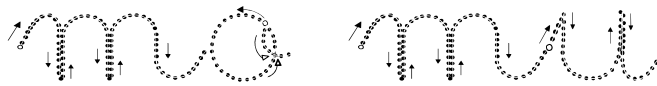
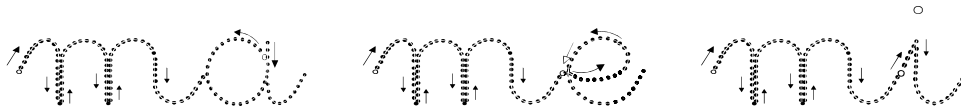
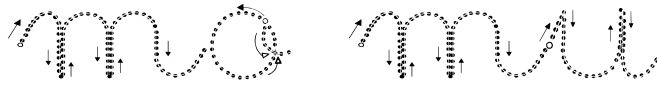
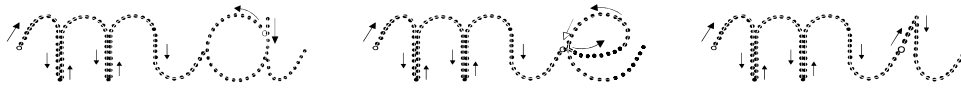



Nombre..... Fecha.....

LA LETRA m

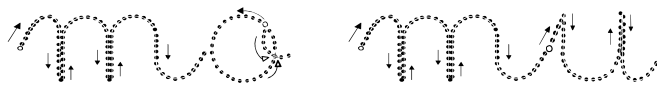
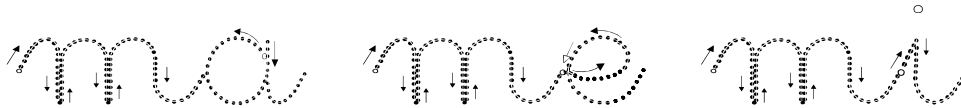
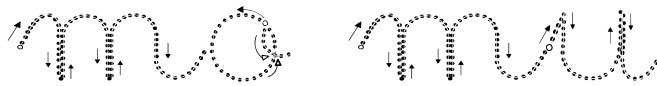
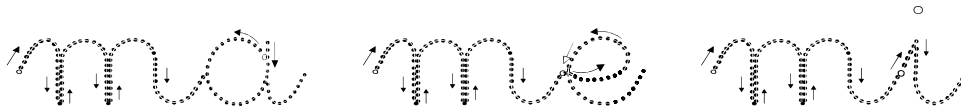
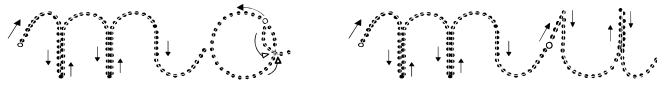
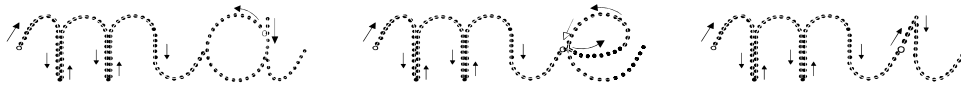



Nombre..... Fecha.....

LA LETRA m



ma me mi mo mu

ma me mi mo mu

mapa mula mal

mapa mula mal

lima eme ama

lima eme ama



Nombre..... Fecha.....

LA LETRA m



ma me mi mo mu

ma me mi mo mu

la mula mala

la mula mala

El mono mome

El mono mome

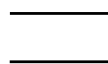



Nombre..... Fecha.....

LA LETRA P



ma me mi mo mu

ma me mi mo mu

Lola pela el polo

Lola pela el polo

Papá oía la lila

Papá oía la lila





Nombre..... Fecha.....

LA LETRA m

ma me mi mo mu

ma me mi mo mu

mula mamá mapa

mula mamá mapa

lima malo momia

lima malo momia



Nombre..... Fecha.....



LA LETRA m

Rodea la letra "m" en estas palabras.

momia mula

mamá mapa

pomo paloma

muleta maleta

eme ama moto



Nombre: Fecha:

LA LETRA m



Rodea las "m" que están bien escritas.



A large rounded rectangle containing ten cursive letters for identification:

- Row 1: m, m, m, m
- Row 2: m, m, m
- Row 3: m, m, m
- Row 4: m, m, m





Nombre: Fecha:

LA LETRA M

Rodea las "M" que están bien escritas.



M W W M
M M W M
W M W M W





Nombre: Fecha:

LA LETRA m y M

 Rodea las "m" y "M" que están bien escritas.

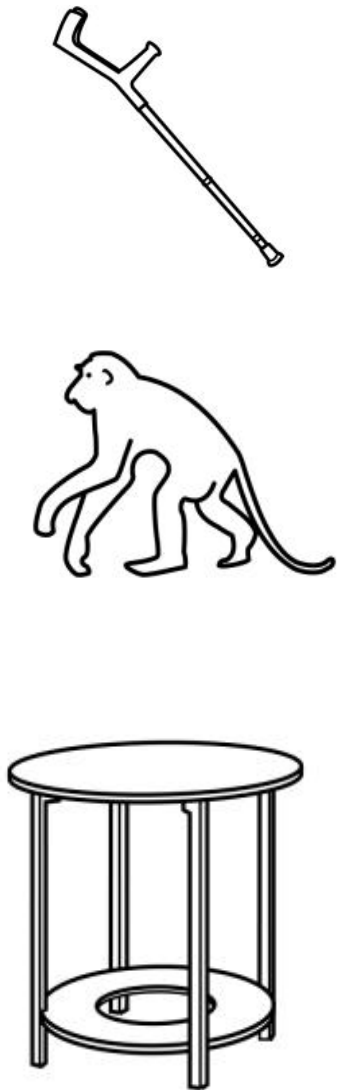

A large rounded rectangle containing a grid of letters for identification. The letters are arranged in four rows and five columns:

| | | | | |
|---|---|---|---|---|
| M | W | W | m | W |
| m | m | m | M | m |
| M | M | m | M | m |
| m | M | W | m | W |

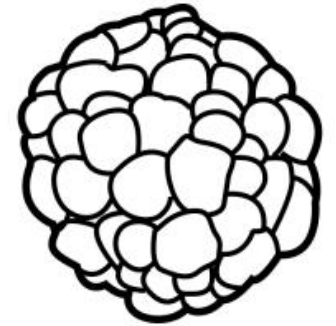



Nombre: Fecha:

LA LETRA m



Rodea las "m" que están bien escritas.

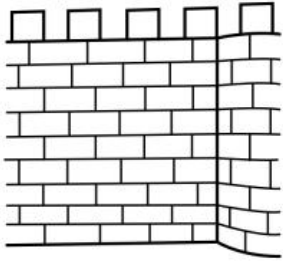

A large rounded rectangle containing 20 different handwritten versions of the letter 'm' for a discrimination task. The letters vary in stroke order, direction, and shape, including some that are upside down or written with multiple loops.

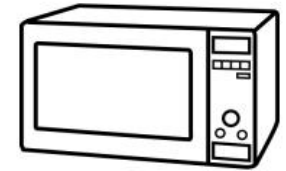



Nombre: Fecha:

LA LETRA M

Rodea las "M" que están bien escritas.



A large rounded rectangle containing a grid of letters for a visual discrimination task. The letters are arranged as follows:

| | | | | |
|---|---|---|---|---|
| M | W | W | M | |
| M | M | W | W | M |
| M | W | M | M | M |

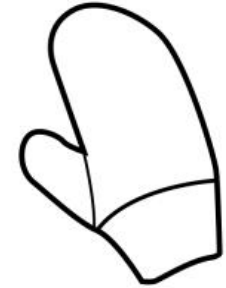
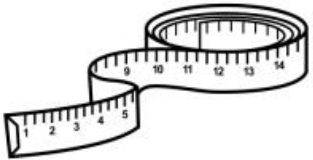



Nombre: Fecha:

LA LETRA M y m

Rodea las "m" y "M" que están bien escritas.



A large rounded rectangle containing a grid of letters 'M' and 'm' in various styles (block letters, cursive, slanted, mirrored) for identification. The letters are arranged in four rows and seven columns:

| | | | | | | |
|---|---|---|---|---|---|---|
| M | M | m | M | m | M | m |
| m | m | M | M | m | m | m |
| m | M | m | M | m | M | m |
| m | M | M | m | M | m | M |

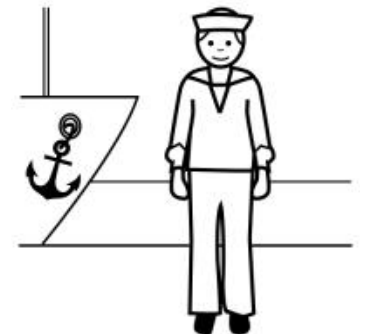
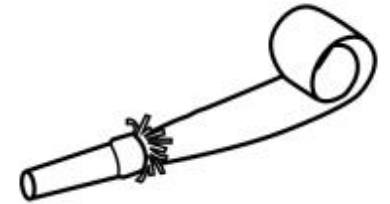
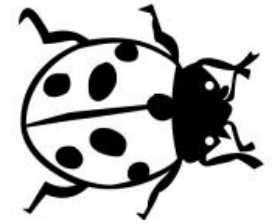



Nombre: Fecha:

LA LETRA m

Rodea las "m" que hay en este lio de letras

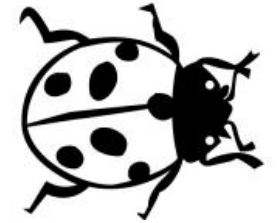

A large rounded rectangle containing a collection of cursive letters for a matching exercise. The letters are arranged in four rows:

- Row 1: f, m, l, r, m, l, q
- Row 2: l, d, ñ, m, g, m
- Row 3: t, x, y, t, r, s, j
- Row 4: m, l, y, m

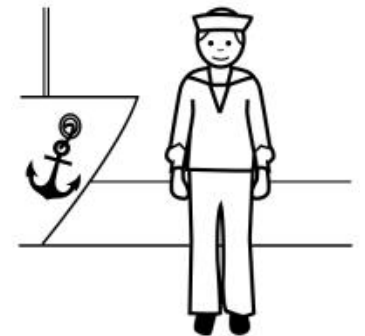
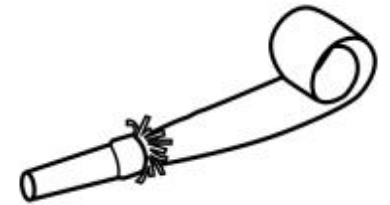



Nombre: Fecha:

LA LETRA M

Rodea las "M" que hay en este lío de letras.

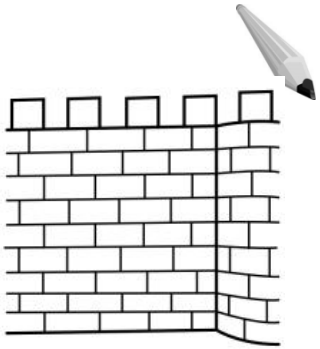

A large rounded rectangle containing a grid of letters for a word search. The letters are arranged in four rows:

| | | | | | | |
|---|---|---|---|---|---|---|
| P | M | N | L | M | B | M |
| C | Z | Q | M | R | V | W |
| H | V | Q | K | L | N | |
| M | D | M | H | M | P | |

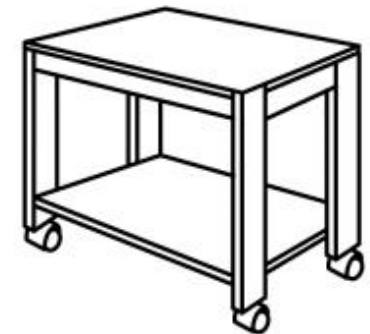
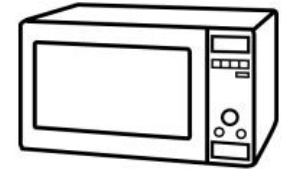



Nombre: Fecha:

LA LETRA m

Rodea las "m" que hay en este lio de letras.



A large rounded rectangle containing a collection of lowercase letters in a cursive font for a word search. The letters are arranged in several rows:

- Row 1: x, h, r, f, ñ, g, p, m, g
- Row 2: l, m, h, t, m, h, y, m, q, r
- Row 3: z, m, h, m, x, t, m, h, f, m, h
- Row 4: p, ñ, d, r, ñ, j, r, x, p, s
- Row 5: l, f, m, p, m, l, r
- Row 6: c, m, w, l, p, m, s, s, t, h
- Row 7: ñ, v, m, t, h, m, m, m





Nombre: Fecha:

LA LETRA M



Rodea las "M" que hay en este lío de letras.

Ñ Ñ N R M B M
J M N Ñ R M B T
C Z M Ñ D W
B X R Q M F T L M Ñ
Ñ L L M H T Ñ
T B M R M T P M

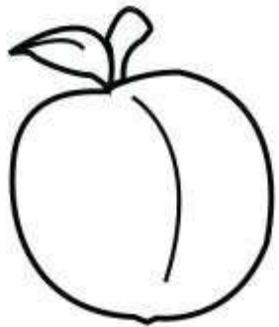



Nombre..... Fecha.....

LA LETRA M

 Unir las sílabas con los dibujos que empiecen por ellas.

ma

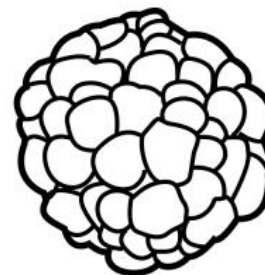

me



mi

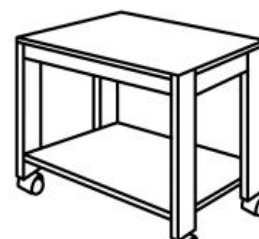

mo



mu





Nombre..... Fecha.....

LA LETRA M

 Unir las sílabas con los dibujos que empiecen por ellas.

ma

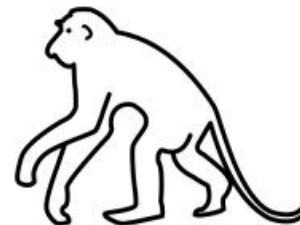

me



mi

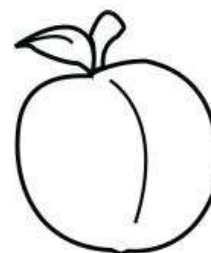

mo



mu

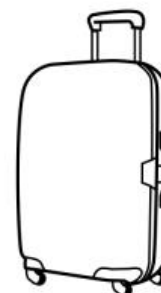



Nombre..... Fecha.....

LA LETRA M

 Unir las sílabas con los dibujos que empiecen por ellas.

ma



me

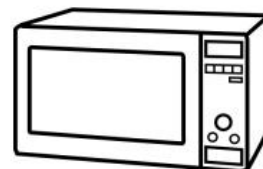

mi



mo



mu





Nombre..... Fecha.....

LA LETRA M

 Unir las sílabas con los dibujos que empiecen por ellas.

ma



me



mi



mo



mu





Nombre..... Fecha.....

LA LETRA M

 Unir las sílabas con los dibujos que empiecen por ellas.

ma

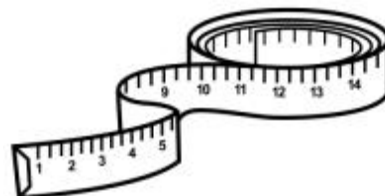

me



mi

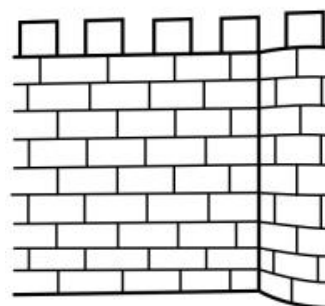

mo



mu





Nombre: Fecha:

LA LETRA m



Recorta las letras para formar estas palabras.

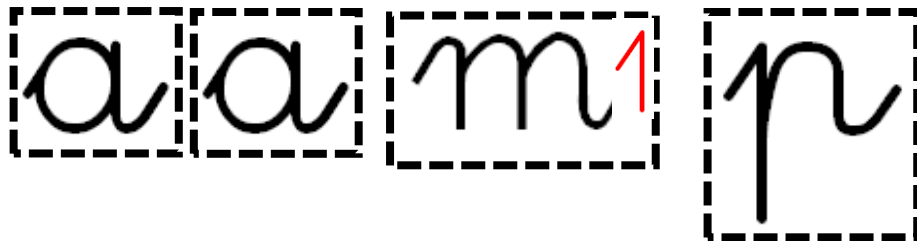
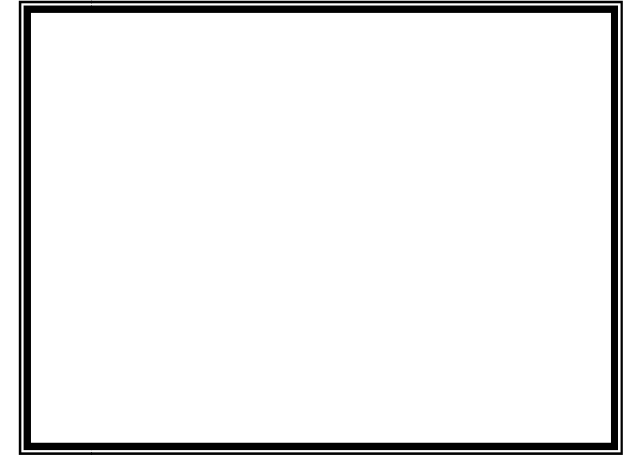
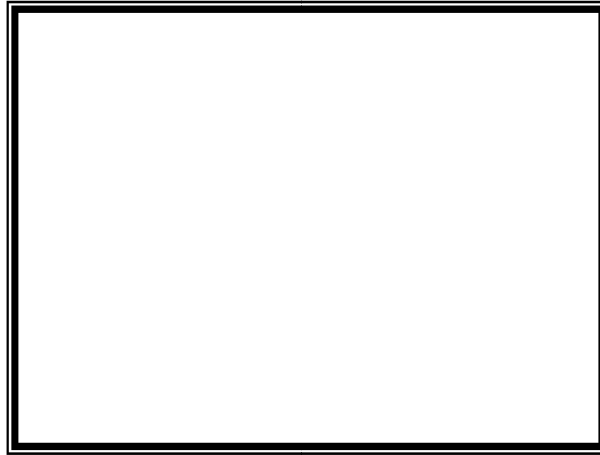
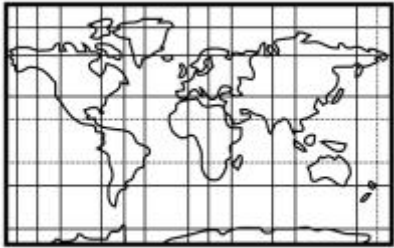











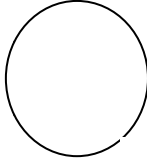

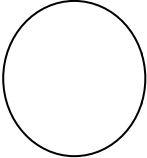

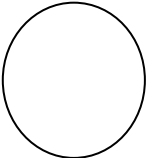

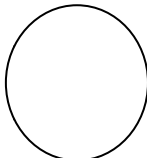

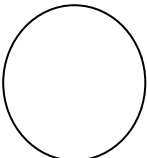

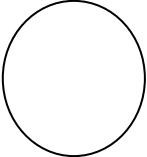

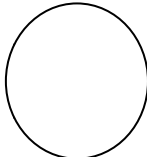

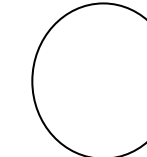
Nombre..... Fecha.....

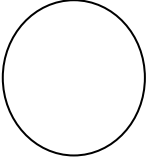
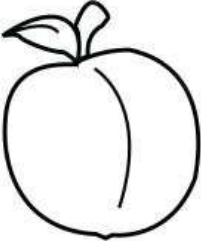
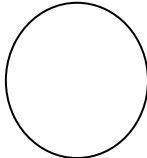
LA LETRA m

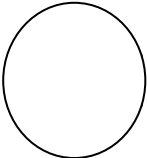
 Escribe la sílaba por la que empiezan los dibujos.













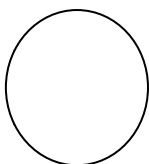
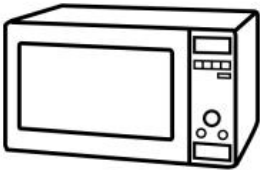
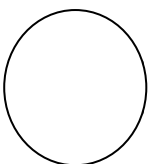

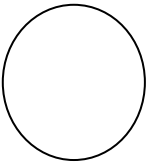

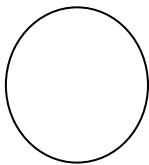
| | | |
|--|--|--|
|   |   |   |
|   |   |   |
|   |   |   |
|   |   |   |

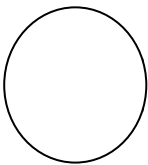
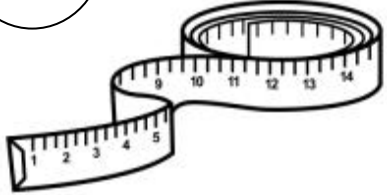
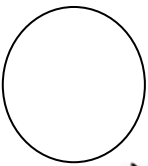
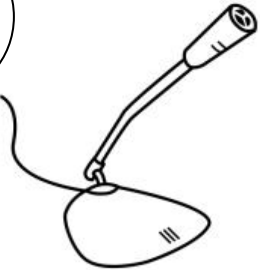
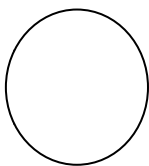

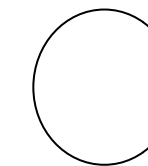
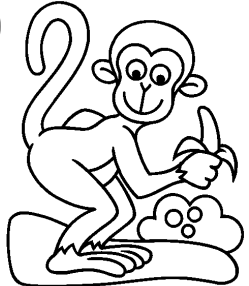
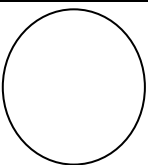
Nombre..... Fecha.....

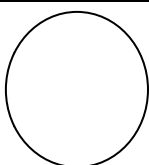
LA LETRA m

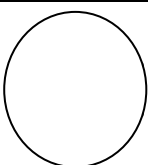
 Escribe la sílaba por la que empiezan los dibujos.













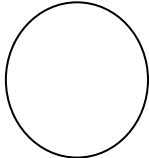

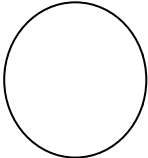

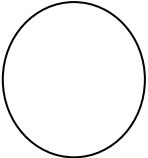

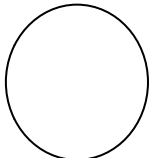
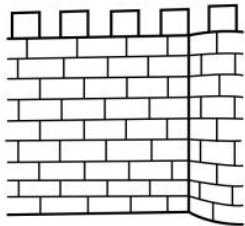
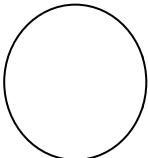

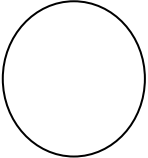

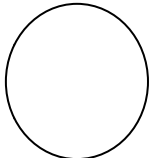
| | | |
|---|---|---|
|   |   |   |
|   |   |   |
|   |   |   |
|   |   |   |

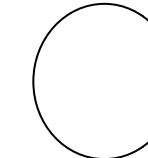

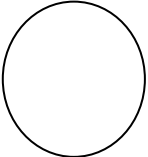
Nombre..... Fecha.....

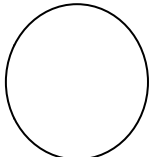
LA LETRA m

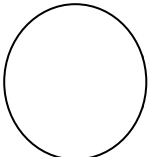
 Escribe la sílaba por la que empiezan los dibujos.













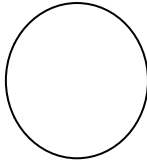

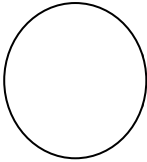

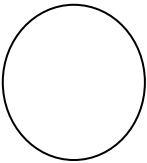
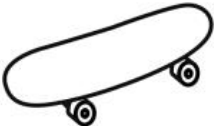
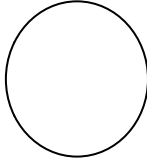
| | | |
|---|---|---|
|   |   |   |
|   |   |   |
|   |   |   |
|   |   |   |

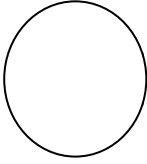
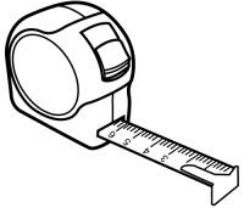
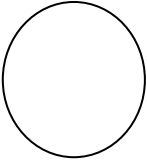

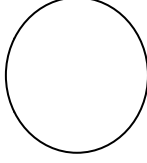
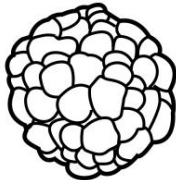
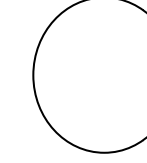
Nombre..... Fecha.....

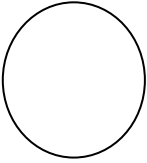
LA LETRA m

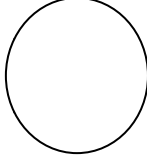
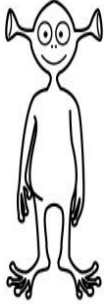
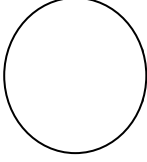
 Escribe la sílaba por la que empiezan los dibujos.













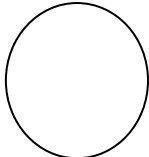

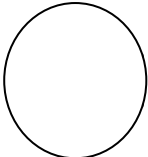

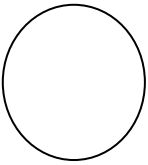

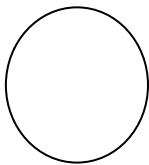
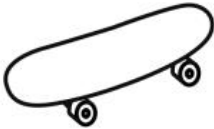
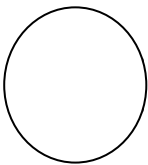

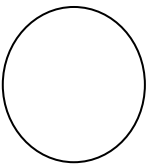
| | | |
|--|--|--|
|   |   |   |
|   |   |   |
|   |   |   |
|   |   |   |

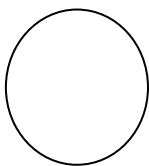

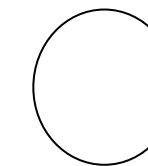
Nombre..... Fecha.....

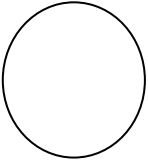
LA LETRA m

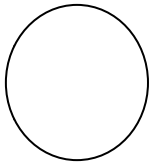
 Escribe la sílaba por la que empiezan los dibujos.

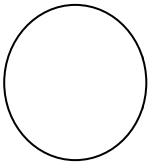
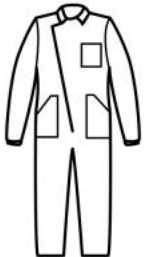
| | | |
|---|---|---|
|   |   |   |
|   |   |   |
|   |   |   |
|   |   |   |



Nombre..... Fecha.....



LA LETRA m

Completa el laberinto con forma de "m".

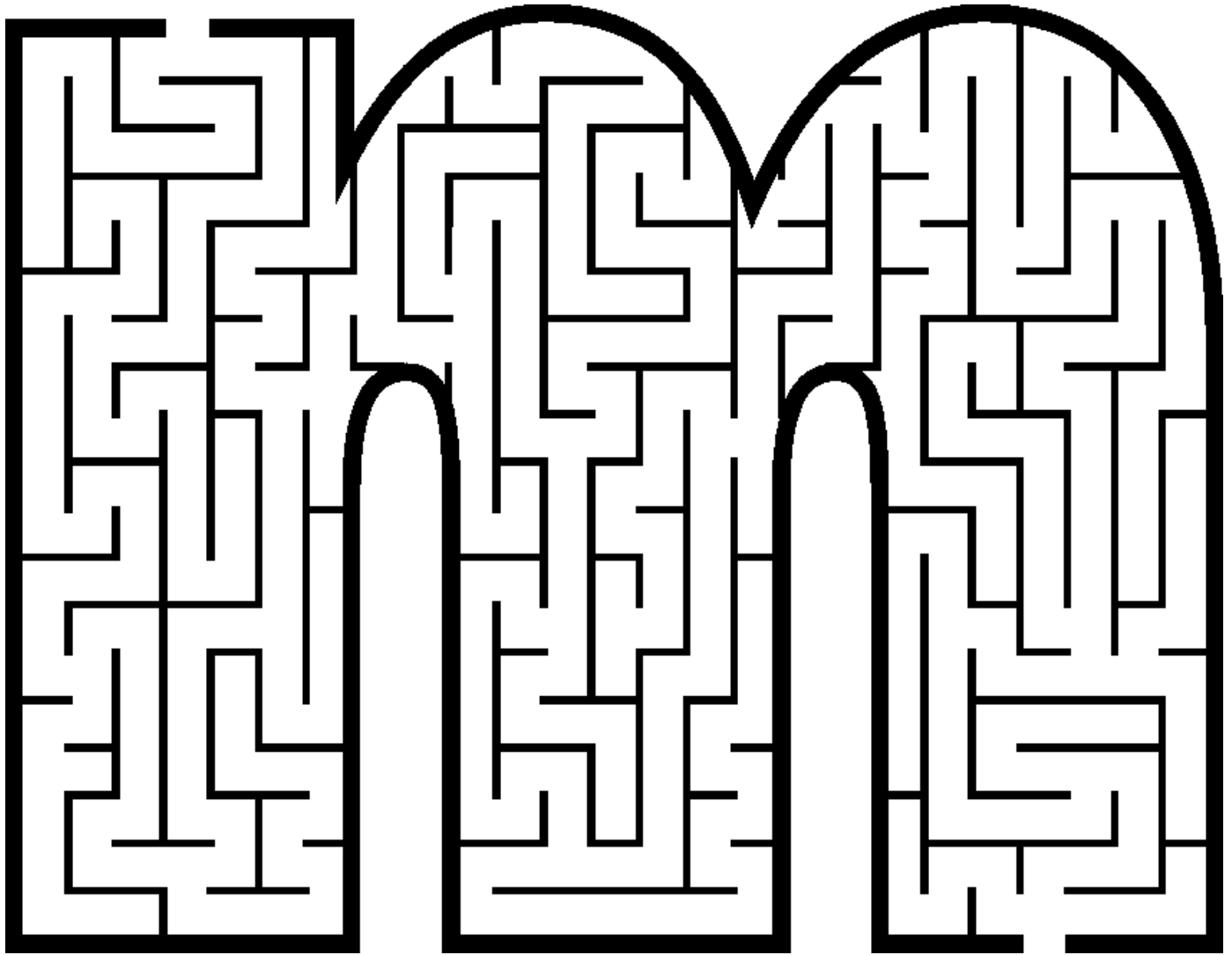



Nombre..... Fecha.....

LA LETRA M

 Completa el laberinto con forma de "M".

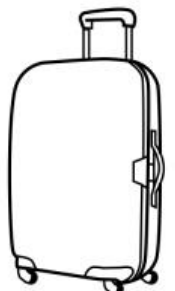
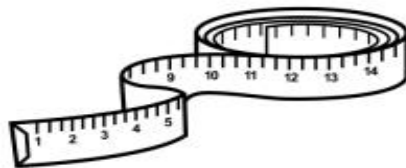
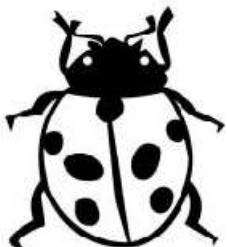
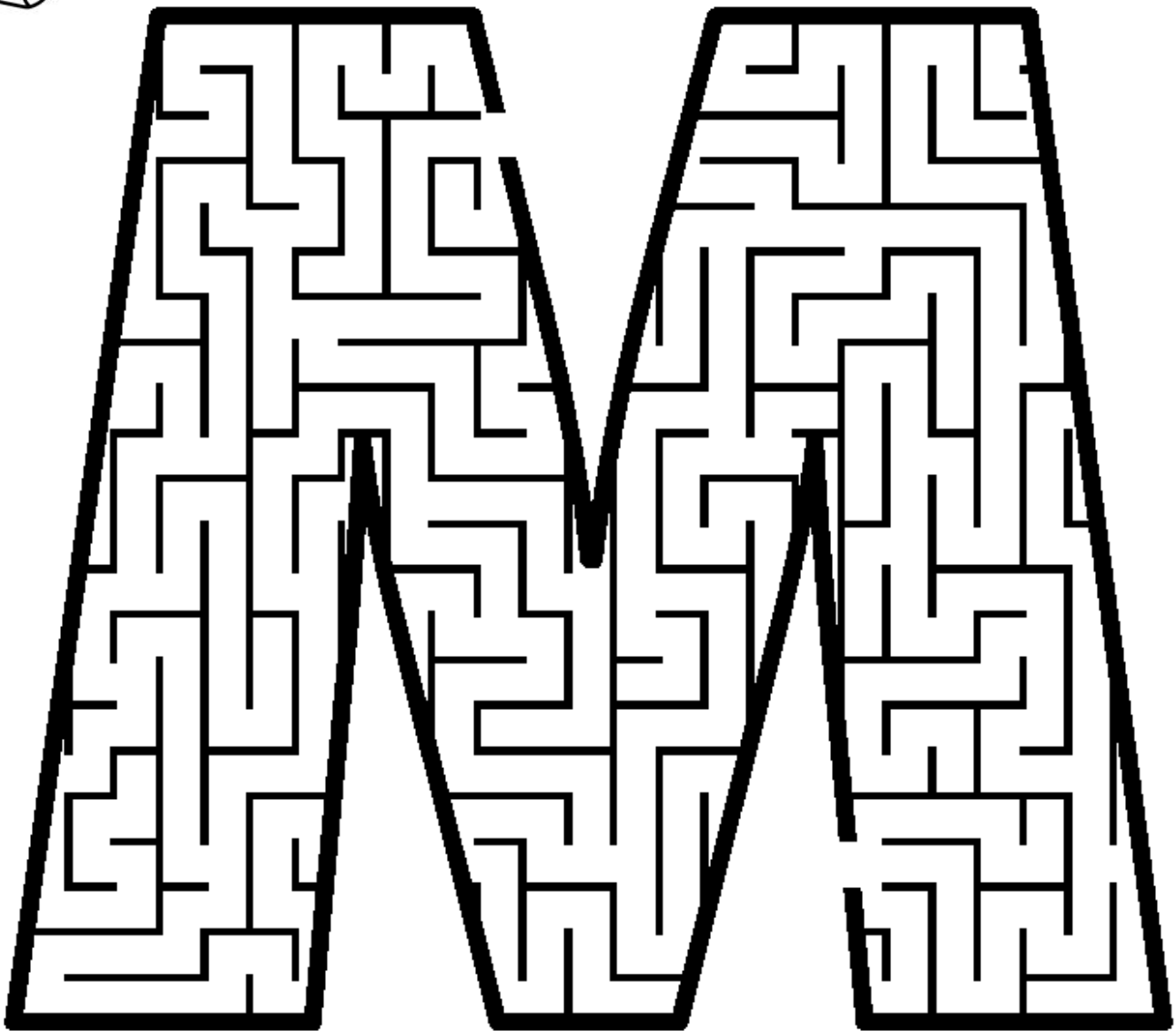













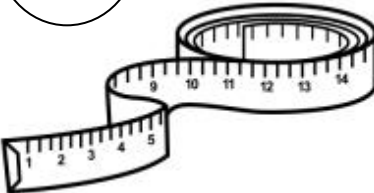

Nombre..... Fecha.....

LA LETRA m



Escribe sí o no en las palabras que lleven la letra m.

| | | |
|--|--|--|
| <input checked="" type="radio"/> sí  | <input checked="" type="radio"/> no  | <input type="radio"/>  |
| <input type="radio"/>  | <input type="radio"/>  | <input type="radio"/>  |
| <input type="radio"/>  | <input type="radio"/>  | <input type="radio"/>  |
| <input type="radio"/>  | <input type="radio"/>  | <input type="radio"/>  |











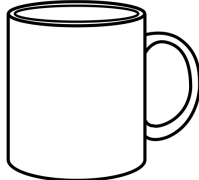

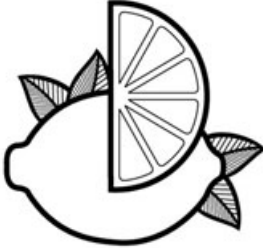
Nombre..... Fecha.....

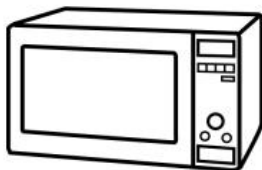
LA LETRA m

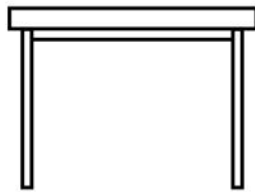

Escribe sí o no en las palabras que lleven la letra m.

| | | |
|--|--|--|
| <input checked="" type="radio"/> sí  | <input checked="" type="radio"/> no  | <input type="radio"/>  |
| <input type="radio"/>  | <input type="radio"/>  | <input type="radio"/>  |
| <input type="radio"/>  | <input type="radio"/>  | <input type="radio"/>  |
| <input type="radio"/>  | <input type="radio"/>  | <input type="radio"/>  |